





8920.15.xxx.S – Cortical Screws Threaded Head Ø 3.5 mm - Labels





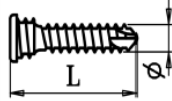
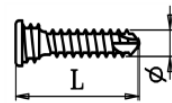

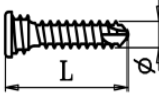



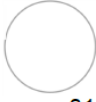

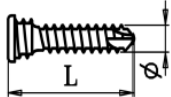
8920.15.xxx.S – Cortical Screws Threaded Head Ø 3.5 mm

<p>REF 8920.15.016.S LOT 2018 T1111 STERILE R 18S2222 2021-12-20</p> <p>Cortical Screw Threaded Head</p> <p>Vite da Corticale Testa Filettata Ø 3.5 x 16 mm</p>  <p>(20)01(240)9892015016S(10)18T1111(91)18S2222(92)6717</p>  <p>(01)08033051097219(17)211220</p> <p>LSM-MED S.r.l. Strada Borrana,38 47899 Serravalle - R.S.M.</p>	 <p>DIPHOS Ø 3.5 mm L. 16 mm</p> <p>QTY: 1</p> <p>LSM-MED S.r.l. REF 8920.15.016.S LOT 2018 T1111 STERILE R 18S2222</p> <p>Ti6Al4V ISO 5832-3 Cortical Bone Screw Vite da Corticale</p> 
<p>REF 8920.15.018.S LOT 2018 T1111 STERILE R 18S2222 2021-12-20</p> <p>Cortical Screw Threaded Head</p> <p>Vite da Corticale Testa Filettata Ø 3.5 x 18 mm</p>  <p>(20)01(240)9892015018S(10)18T1111(91)18S2222(92)6764</p>  <p>(01)08033051097233(17)211220</p> <p>LSM-MED S.r.l. Strada Borrana,38 47899 Serravalle - R.S.M.</p>	 <p>DIPHOS Ø 3.5 mm L. 18 mm</p> <p>QTY: 1</p> <p>LSM-MED S.r.l. REF 8920.15.018.S LOT 2018 T1111 STERILE R 18S2222</p> <p>Ti6Al4V ISO 5832-3 Cortical Bone Screw Vite da Corticale</p> 
<p>REF 8920.15.020.S LOT 2018 T1111 STERILE R 18S2222 2021-12-20</p> <p>Cortical Screw Threaded Head</p> <p>Vite da Corticale Testa Filettata Ø 3.5 x 20 mm</p>  <p>(20)01(240)9892015020S(10)18T1111(91)18S2222(92)6739</p>  <p>(01)08033051097257(17)211220</p> <p>LSM-MED S.r.l. Strada Borrana,38 47899 Serravalle - R.S.M.</p>	 <p>DIPHOS Ø 3.5 mm L. 20 mm</p> <p>QTY: 1</p> <p>LSM-MED S.r.l. REF 8920.15.020.S LOT 2018 T1111 STERILE R 18S2222</p> <p>Ti6Al4V ISO 5832-3 Cortical Bone Screw Vite da Corticale</p> 

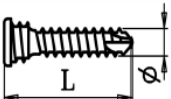



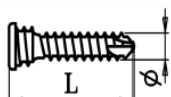





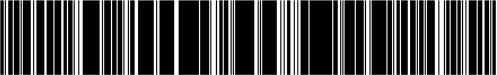

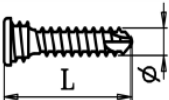
8920.15.xxx.S – Cortical Screws Threaded Head Ø 3.5 mm - Labels

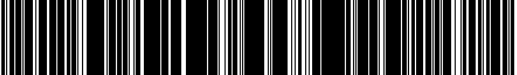
<p>REF 8920.15.022.S CE  0426</p> <p>LOT 2018 T1111</p> <p>STERILE R 18S2222 2021-12-20</p> <p>Cortical Screw Threaded Head</p> <p>01</p> <p>Vite da Corticale Testa Filettata Ø 3.5 x 22 mm</p>  <p>(20)01(240)9892015022S(10)18T1111(91)18S2222(92)6714</p>  <p>(01)08033051097271(17)211220</p> <hr/> <p>LSM-MED S.r.l. Strada Borrana,38 47899 Serravalle - R.S.M.</p>	<p> DIPHOS Ø 3.5 mm L. 22 mm</p> <p align="center">QTY: 1</p> <p>LSM-MED S.r.l.</p> <p>REF 8920.15.022.S</p> <p>LOT 2018 T1111 STERILE R 18S2222</p> <p>Ti6Al4V ISO 5832-3 Cortical Bone Screw Vite da Corticale</p> 
<p>REF 8920.15.024.S CE  0426</p> <p>LOT 2018 T1111</p> <p>STERILE R 18S2222 2021-12-20</p> <p>Cortical Screw Threaded Head</p> <p>01</p> <p>Vite da Corticale Testa Filettata Ø 3.5 x 24 mm</p>  <p>(20)01(240)9892015024S(10)18T1111(91)18S2222(92)6719</p>  <p>(01)08033051097295(17)211220</p> <hr/> <p>LSM-MED S.r.l. Strada Borrana,38 47899 Serravalle - R.S.M.</p>	<p> DIPHOS Ø 3.5 mm L. 24 mm</p> <p align="center">QTY: 1</p> <p>LSM-MED S.r.l.</p> <p>REF 8920.15.024.S</p> <p>LOT 2018 T1111 STERILE R 18S2222</p> <p>Ti6Al4V ISO 5832-3 Cortical Bone Screw Vite da Corticale</p> 
<p>REF 8920.15.026.S CE  0426</p> <p>LOT 2018 T1111</p> <p>STERILE R 18S2222 2021-12-20</p> <p>Cortical Screw Threaded Head</p> <p>01</p> <p>Vite da Corticale Testa Filettata Ø 3.5 x 26 mm</p>  <p>(20)01(240)9892015026S(10)18T1111(91)18S2222(92)6735</p>  <p>(01)08033051097318(17)211220</p> <hr/> <p>LSM-MED S.r.l. Strada Borrana,38 47899 Serravalle - R.S.M.</p>	<p> DIPHOS Ø 3.5 mm L. 26 mm</p> <p align="center">QTY: 1</p> <p>LSM-MED S.r.l.</p> <p>REF 8920.15.026.S</p> <p>LOT 2018 T1111 STERILE R 18S2222</p> <p>Ti6Al4V ISO 5832-3 Cortical Bone Screw Vite da Corticale</p> 

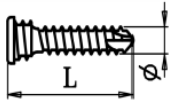

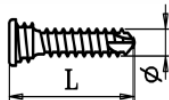

8920.15.xxx.S – Cortical Screws Threaded Head Ø 3.5 mm - Labels

<p>REF 8920.15.028.S CE  0426 01</p> <p>LOT 2018 T1111</p> <p>STERILE R 18S2222 ⏰ 2021-12-20</p> <p>Cortical Screw Threaded Head</p> <p>Vite da Corticale Testa Filettata Ø 3.5 x 28 mm</p>  <p>(20)01(240)9892015028S(10)18T1111(91)18S2222(92)6767</p>  <p>(01)08033051097332(17)211220</p> <p>LSM-MED S.r.l. Strada Borrana,38 47899 Serravalle - R.S.M.</p>	 <p>DIPHOS Ø 3.5 mm L. 28 mm</p> <p>QTY: 1</p> <p>LSM-MED S.r.l.</p> <p>REF 8920.15.028.S</p> <p>LOT 2018 T1111 STERILE R 18S2222</p> <p>Ti6Al4V ISO 5832-3 Cortical Bone Screw Vite da Corticale</p> 
<p>REF 8920.15.030.S CE  0426 01</p> <p>LOT 2018 T1111</p> <p>STERILE R 18S2222 ⏰ 2021-12-20</p> <p>Cortical Screw Threaded Head</p> <p>Vite da Corticale Testa Filettata Ø 3.5 x 30 mm</p>  <p>(20)01(240)9892015030S(10)18T1111(91)18S2222(92)6721</p>  <p>(01)08033051097356(17)211220</p> <p>LSM-MED S.r.l. Strada Borrana,38 47899 Serravalle - R.S.M.</p>	 <p>DIPHOS Ø 3.5 mm L. 30 mm</p> <p>QTY: 1</p> <p>LSM-MED S.r.l.</p> <p>REF 8920.15.030.S</p> <p>LOT 2018 T1111 STERILE R 18S2222</p> <p>Ti6Al4V ISO 5832-3 Cortical Bone Screw Vite da Corticale</p> 
<p>REF 8920.15.032.S CE  0426 01</p> <p>LOT 2018 T1111</p> <p>STERILE R 18S2222 ⏰ 2021-12-20</p> <p>Cortical Screw Threaded Head</p> <p>Vite da Corticale Testa Filettata Ø 3.5 x 32 mm</p>  <p>(20)01(240)9892015032S(10)18T1111(91)18S2222(92)6761</p>  <p>(01)08033051097370(17)211220</p> <p>LSM-MED S.r.l. Strada Borrana,38 47899 Serravalle - R.S.M.</p>	 <p>DIPHOS Ø 3.5 mm L. 32 mm</p> <p>QTY: 1</p> <p>LSM-MED S.r.l.</p> <p>REF 8920.15.032.S</p> <p>LOT 2018 T1111 STERILE R 18S2222</p> <p>Ti6Al4V ISO 5832-3 Cortical Bone Screw Vite da Corticale</p> 

8920.15.xxx.S – Cortical Screws Threaded Head Ø 3.5 mm - Labels

<p>REF 8920.15.034.S LOT 2018 T1111 STERILE R 18S2222 2021-12-20</p> <p>Cortical Screw Threaded Head</p> <p>Vite da Corticale Testa Filettata Ø 3.5 x 34 mm</p>  <p>(20)01(240)9892015034S(10)18T1111(91)18S2222(92)6728</p>  <p>(01)08033051097394(17)211220</p> <p>LSM-MED S.r.l. Strada Borrana,38 47899 Serravalle - R.S.M.</p>	<p>DIPHOS Ø 3.5 mm L. 34 mm</p>  <p>QTY: 1</p> <p>LSM-MED S.r.l.</p> <p>REF 8920.15.034.S LOT 2018 T1111 STERILE R 18S2222</p> <p>Ti6Al4V ISO 5832-3 Cortical Bone Screw Vite da Corticale</p> 
<p>REF 8920.15.036.S LOT 2018 T1111 STERILE R 18S2222 2021-12-20</p> <p>Cortical Screw Threaded Head</p> <p>Vite da Corticale Testa Filettata Ø 3.5 x 36 mm</p>  <p>(20)01(240)9892015036S(10)18T1111(91)18S2222(92)6746</p>  <p>(01)08033051097417(17)211220</p> <p>LSM-MED S.r.l. Strada Borrana,38 47899 Serravalle - R.S.M.</p>	<p>DIPHOS Ø 3.5 mm L. 36 mm</p>  <p>QTY: 1</p> <p>LSM-MED S.r.l.</p> <p>REF 8920.15.036.S LOT 2018 T1111 STERILE R 18S2222</p> <p>Ti6Al4V ISO 5832-3 Cortical Bone Screw Vite da Corticale</p> 
<p>REF 8920.15.038.S LOT 2018 T1111 STERILE R 18S2222 2021-12-20</p> <p>Cortical Screw Threaded Head</p> <p>Vite da Corticale Testa Filettata Ø 3.5 x 38 mm</p>  <p>(20)01(240)9892015038S(10)18T1111(91)18S2222(92)6792</p>  <p>(01)08033051097431(17)211220</p> <p>LSM-MED S.r.l. Strada Borrana,38 47899 Serravalle - R.S.M.</p>	<p>DIPHOS Ø 3.5 mm L. 38 mm</p>  <p>QTY: 1</p> <p>LSM-MED S.r.l.</p> <p>REF 8920.15.038.S LOT 2018 T1111 STERILE R 18S2222</p> <p>Ti6Al4V ISO 5832-3 Cortical Bone Screw Vite da Corticale</p> 

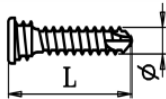
8920.15.xxx.S – Cortical Screws Threaded Head Ø 3.5 mm - Labels

<p>REF 8920.15.040.S LOT 2018 T1111 STERILE R 18S2222 2021-12-20 Cortical Screw Threaded Head</p> <p>Vite da Corticale Testa Filettata Ø 3.5 x 40 mm</p>  <p>(20)01(240)9892015040S(10)18T1111(91)18S2222(92)6713</p>  <p>(01)08033051097455(17)211220</p> <p>LSM-MED S.r.l. Strada Borrana,38 47899 Serravalle - R.S.M.</p>	<p>CE 0426  01</p>  <p>DIPHOS Ø 3.5 mm L. 40 mm</p> <p>QTY: 1</p> <p>LSM-MED S.r.l.</p> <p>REF 8920.15.040.S LOT 2018 T1111 STERILE R 18S2222 Ti6Al4V ISO 5832-3 Cortical Bone Screw Vite da Corticale</p> 
---	--